

SPECIFICATION PROCEDURES

(also see the separate installation do's and don'ts and installation instructions)

☞ The purpose of any kitchen ventilation system is to completely remove the cooking contaminants of heat, steam, grease, smoke, odors and hazardous gases, before they have a chance to mix with the air in the rest of the home.

Range hoods and liners must be properly designed and installed in order for them to be effective. No manufacturers exhaust system will work properly if it is poorly designed and/or improperly installed. If a Vent-A-Hood does not seem to be working properly, there could be a mechanical problem with the hood, but that is by far the least likely cause. Vent-A-Hood, properly specified and installed, works - period!

Poor design and/or improper installation are the first places to look if the ventilator is not removing the cooking pollutants.

The first step in specifying a range hood or liner (hereafter, rh/l) involves answering these two questions:

- 1). What type of cooking equipment is involved?
 - A standard gas appliance.
 - A standard electric appliance.
 - A professional-style gas appliance.
- 2). What type of rh/l is required?
 - Undercabinet
 - Wall Mount
 - Island
 - Metal liner for a wood hood (wall mount or island?)

The second step is to arrive at physical specifications relating to the six performance variables outlined below. These critical variables interact with one another and a deficiency in any one of these areas can cause a rh/l to perform poorly.

1). Height

Capture area is very important in rh/l performance, especially with professional-style appliances. Generally, taller rh/l have more capture area than shorter ones. Rh/l height is determined by the type of appliance under it, by the height of the ceiling and anything that may be above the rh/l such as a soffit, cabinet or duct cover.

2). Width

- ☞ A rh/l should never be narrower than the appliance it is ventilating.
- ☞ Wherever possible, undercabinet and wall mount rh/l should overlap standard appliances by 3"-6" on each side.
- ☞ Island rh/l and rh/l over professional-style appliances must overlap by at least 3" on each side.

3). Depth

Rh/l should be deep enough to fully cover all burners.

- ☞ 6" tall undercabinet rh/l must not be used over professional-style appliances.
- ☞ 9" tall undercabinet hoods should not be installed over professional-style appliances exceeding 30" in width. Some situations, such as a corner installation, may require a non-standard depth.
- ☞ Wall mount rh/l should be 24" deep for standard appliances and most professional-style appliances. A 27" depth is required for some professional-style appliances. Some situations, such as a corner installation, may require a non-standard depth.
- ☞ Island rh/l should be 27" deep for standard appliances and 30" deep for professional-style appliances.

4). Proximity

For best performance, there is a maximum height at which rh/l should be installed.

- ☞ 6" tall undercabinet rh/l should be mounted with the bottom 21"-24" above the cooking surface.
- ☞ 9" tall undercabinet hoods should be mounted with the bottom 24"-27" above the cooking surface.
- ☞ Wall mount and island rh/l should be mounted with the bottom no higher than 30" above the cooking surface.

(Cont'd)

(SPECIFICATION PROCEDURES Cont'd)

5). Blower Configuration

Customers cooking habits and expectations of their ventilation equipment vary. The recommendations in the table below will provide excellent results under a majority of situations. Customers desiring the highest possible removal of cooking contaminants should contact a Vent-A-Hood dealer for a consultation.

HOOD/LINER TYPE	COOKING EQUIPMENT TYPE	USAGES L = Light M = Medium H = Heavy *	MULTI-BURNER COOKTOP RATING	BBQ, WOK or GRIDDLE	MAGIC LUNG® BLOWER(S) **	EQUIVALENT CFM **
"K-Series"	Standard gas Standard electric	No L/M	12,000 WATTS	Do Not Use!	240 CFM single blower	360 CFM
"Classic", SLH6, 6" tall undercabinet	Standard gas Standard electric	L L/M	20,000-30,000 BTU 12,000 WATTS	Do Not Use!	300 CFM (B100 single blower)	450 CFM
9" tall undercabinet or wall mount	Standard gas Standard electric	L L/M		20,000 BTU 12,000 WATTS		
9" tall undercabinet	Standard gas Standard electric 30" Pro-style	M/H H L	40,000-60,000 BTU 24,000 WATTS	40,000 BTU 24,000 WATTS	600 CFM (B200 dual blower)	900 CFM
Wall Mount	Standard gas Standard electric 30" Pro-style 36" Pro-style	M/H H L/M L				
	36" Pro-style 48" Pro-style	M/H L/M				
	48" Pro-style 60" Pro-style	H All	80,000-120,000 BTU 48,000 WATTS	80,000 BTU 48,000 WATTS	1200 CFM (Two B200 dual blowers)	1800 CFM
Island	Standard gas Standard electric 30" Pro-style 36" Pro-style	All All L/M L	40,000-60,000 BTU 24,000 WATTS	40,000 BTU 24,000 WATTS	550 CFM (T200 island dual blower)	900 CFM
	36" Pro-style 48" - 60" Pro-style	M/H All	80,000-120,000 BTU 48,000 WATTS	80,000 BTU 48,000 WATTS	1100 CFM (T400 island cluster blower)	1800 CFM

* Heavy usage on a standard appliance is defined as 3-4 burners frequently in use, canning, wok cooking, frying, grill/griddle in cooktop.

* Heavy usage on a professional appliance is defined by the appliance itself and the customers cooking practices. To help with decisions about blower capacity, a good rule of thumb is that a single, 300 CFM Magic Lung® blower will handle up to 20,000 BTU's.

** CFM ratings, for hoods using mesh or baffle filters, are overstated by approximately 1/3 because they are tested without the filters in place. A mesh or baffle filtered hood, rated at 450 CFM, actually delivers only about 300 CFM of airflow after the filters are placed in the air stream.

Because it uses a centrifugal filtration system with nothing to obstruct the airflow, the Vent-A-Hood Magic Lung® blower is much more efficient, delivering airflow equivalent to a "filtered" hood - but with a lower CFM rating. When comparing the Magic Lung® to blower units made by other manufacturers, use the "Equivalent CFM".

6). Make-up Air

Air is drawn from the home in many ways, including fireplaces, bathfans, ceiling fans, kitchen ventilation etc., creating the potential for the air pressure inside the house to become significantly less than that outside the house (negative pressure). These two pressure levels will attempt to equalize, with air infiltrating into the home via the easiest pathway possible. In todays tighter homes, the pressure may equalize by backdrafting water heater flues, furnace flues and fireplace chimneys.

Backdrafting is a potentially dangerous situation that can be avoided by replacing air, removed from the home, via a safe pathway from the outside (make-up air). If it is starved of air to exhaust due to inadequate make-up air, a rh/l may perform poorly, evidenced by cooking contaminants not being completely exhausted to the outside. Present your appliance and ventilation choice to a qualified HVAC professional who can determine how much, if any, make-up air is needed.

For additional assistance, at this web site: www.shadyoakdist.com - click on "Vent-A-Hood" and under "General Information" click on "Facts to gather prior to visiting your Vent-A-Hood dealer."

Indoor air quality begins with an appliance properly vented by Vent-A-Hood !

Distributed By: Shady Oak Distributing, 616 - 13th Ave. South, Hopkins, MN 55343

Ph: (952) 935-3305

Toll Free: (888) 933-6529

Fax: (952) 224-3610

Rev. 9/08

"K-SERIES" INSTALLATION DO'S & DON'TS

(also see the separate specification procedures and installation instructions)

Range hoods and liners must be properly designed and installed in order for them to be effective. No manufacturers exhaust system will work properly if it is poorly designed and/or improperly installed. If a Vent-A-Hood does not seem to be working properly, there could be a mechanical problem with the hood, but that is far-and-away the least likely cause. Vent-A-Hood, properly specified and installed, works - period! The problem is virtually always a violation of one or more of the 11 items detailed below.

Poor design and/or improper installation are the first places to look if the ventilator is not removing the cooking pollutants.

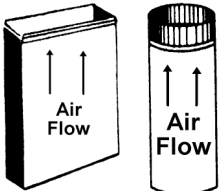
- 1).  Use properly sized, smooth galvanized ductwork, making the duct run as short and straight as possible.

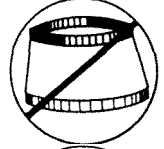
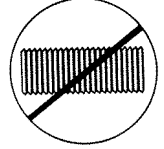
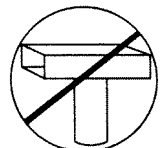
<u>Blower</u>	<u>Correct Duct Size</u>	<u>Round Equivalent</u>
240cfm	3-1/4" x 10" (32.5 sq. in.)	7" (38.5 sq. in.)
- 2).  DO NOT reduce the suggested minimum duct size, (as outlined above), ANYWHERE in the duct run. Even at the wall cap or roof jack. A 5" duct in place of a 6" duct will reduce a 300cfm air flow to 205cfm and a 7" duct in place of an 8" duct will reduce a 600cfm air flow to 400cfm.
- 3).  DO NOT USE flexible ductwork. The ribbing creates resistance to air flow and reduces exhaust efficiency tremendously.
- 4).  DO NOT TURN SHARP CORNERS. Make gradual turns in the duct run. Rapidly moving air cannot make sharp 90° turns.
- 5). IF AT ALL POSSIBLE - do not space 90° elbows closer than 6 feet to each other.
- 6). TAPE ALL JOINTS with duct tape in order to prevent leakage of any pollutants into the wall, joist, basement or attic spaces.
- 7). DO NOT USE SCREWS to attach ductwork to the duct collar on the top/back of the hood. Protruding screws may keep the backdraft damper from opening and closing properly.
Make sure all backdraft dampers open and close completely and freely!
- 8). INSULATE THE DUCTWORK in cold spaces to prevent moisture condensation in the winter, which can run down the ductwork into the cabinet below.
- 9). NO SCREENING MATERIAL on the wall caps or roof jacks. Screens cut air flow by 20-50% and should not be used.
- 10). THE AIR SHOULD NOT "DEAD END" into the top of wall caps or roof jacks. Openings on wall caps or roof jacks should be wide enough and deep enough to allow the air to flow continuously and freely. Wall caps and roof jacks should have solid, gravity dampers that will open and close freely with the air flow.
Vent-A-Hood dealers have access to all the appropriate wall caps and roof jacks.
- 11). Due to tighter construction techniques being used in homes today, it is important to replace any air removed from the home via a safe pathway from the outside. If this is not done, the possibility exists that fireplaces, furnace flues etc. may be backdrafted. If it is starved of air to exhaust due to inadequate make-up air, a range hood or liner may perform poorly, evidenced by cooking contaminants not being completely exhausted to the outside. To avoid these potential problems, consult an HVAC professional who is qualified to determine if, and how much, make-up air is needed.

Thank you for choosing *Vent-A-Hood* !

Vent Hood® WALL MOUNT LINER INSERT SPECIFICATIONS

KHSLD LINER Halogen lights only. This model not available with heat lamps. This model only available in Black, Biscuit, Gunsmoke Gray, Stainless Steel, or White.

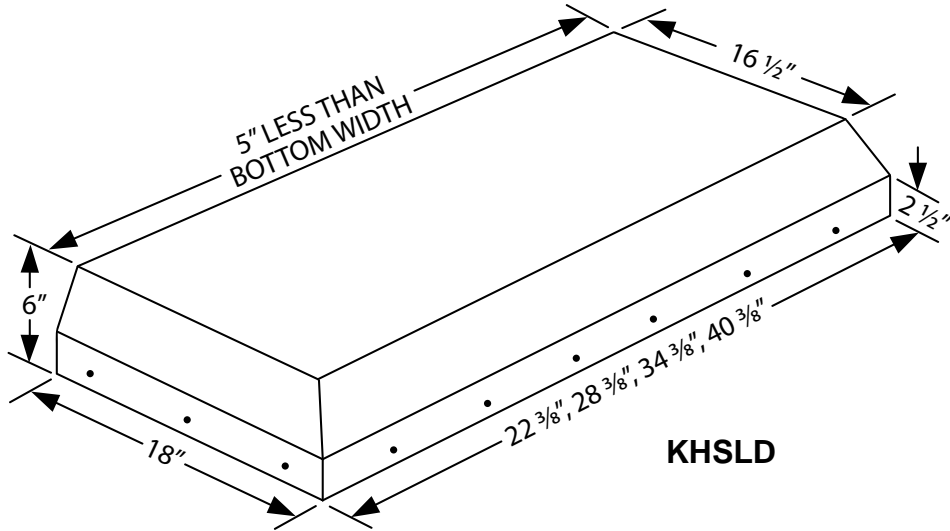

The VP521 transition is available for top vent applications at an additional charge.

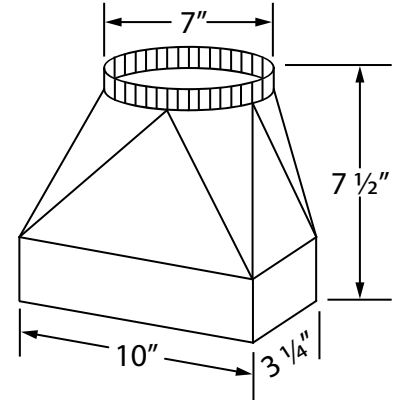

Top Vent or Back Vent
3 1/4" x 10"

KHSLD

Connection Diagrams (22 3/8", 28 3/8", 34 3/4", & 40 3/8" Widths)

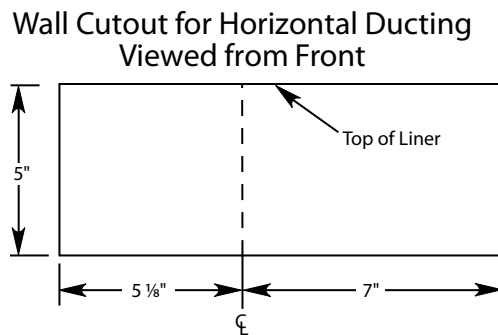
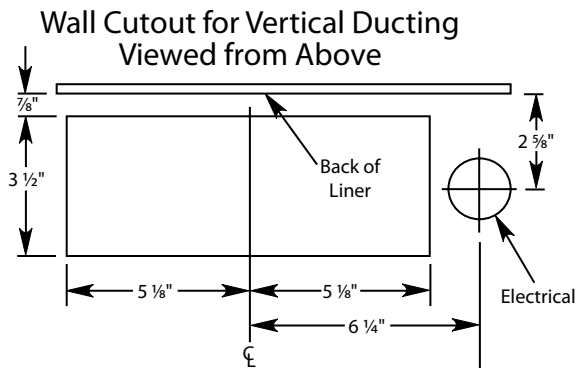

Recommended Mounting Height*

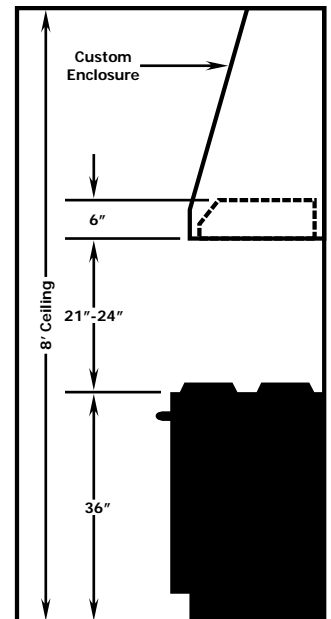

*Exceeding recommended mounting height may compromise performance.

Electrical/Mechanical Specifications For Blower Units

Model	Volts	Amps	Hz	RPM	CFM SP@0.0"	Equivalent CFM*	CFM SP@0.1"	CFM SP@0.2"	CFM SP@0.3"	Minimum Round Duct Size	Sones#
K250 (Top Vent)	115	3.2	60	1550	250	375	223	220	190	7" (38 in. ²)	7.4
K250 (Back Vent)	115	3.2	60	1550	220	330	215	195	180	7" (38 in. ²)	7.4

All K-Series hoods have two halogen lights.
 * Because the Magic Lung® blower uses centrifugal filtration rather than conventional baffle or mesh filters, the Magic Lung® blower can handle cooking equipment with higher cubic feet per minute (CFM) requirements and can deliver equivalent CFM much more efficiently than other filtration systems. When comparing the Magic Lung® with other blower units made by other manufacturers, use the "Equivalent CFM".
 # Ratings in accordance with the Standard Test Code by the Energy Systems Laboratory of the Texas Engineering Experiment Station.